

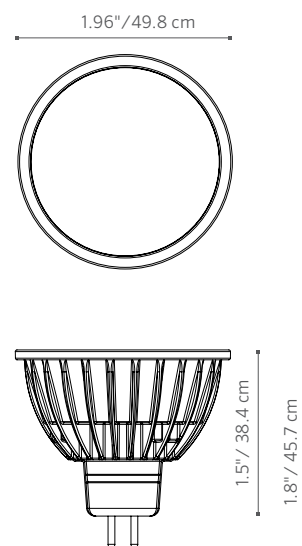

The MR-16 LED is a convenient high-quality lamp. The MR-16 LED is available in two intensities, four beam angle options, and two color temperatures. Fully potted, it carries a five-year warranty.

## MR-16: LED Lamp

BASE:	GU5.3
HOUSING:	Die-cast zinc
INPUT VOLTAGE:	10 to 15V
LAMP LIFE:	40,000 hours
COLOR TEMPERATURE (CCT):	2700K and 3900K
BEAM ANGLES:	10° - Very narrow flood 25° - Narrow flood 35° - Flood 60° - Wide flood
COMPLIANCE:	UL, cUL, FCC, and RoHS
WARRANTY:	5 year limited





# MR-16: LED Lamp

**MODEL CONFIGURATION:**

**MR-16** **LED**

Halogen Equivalent

20 20W  
35 35W

Color Temperature

W Warm (2700K)  
C Cool (3900K)

Beam Angle

VN Very narrow (10°)  
NF Narrow flood (25°)  
FL Flood (35°)  
WF Wide flood (60°)

**FIELD INSTALLED OPTIONS: Order Individually**

Hex Baffle (250015260000)

Recessor Ring (RRMR16)

Frosted Lens (250015170000)

Spread Lens (250013550000)

Solite Spread Lens (250015240000)

**ORDERING INFORMATION:**

Model No.	Description	Watts	VA	Equivalent Wattage	CCT	Beam Spread	Max Lumens	CBCP	CRI	Efficacy
MR16LED20WVN	Very Narrow Flood	4.0	4.3	20W	2700K	10	270	4610	79	67
MR16LED20WNF	Narrow Flood	4.0	4.3	20W	2700K	25	270	1690	79	67
MR16LED20WFL	Flood	4.0	4.3	20W	2700K	35	260	750	80	65
MR16LED20WVF	Wide Flood	4.0	4.3	20W	2700K	60	250	290	80	64
MR16LED20CVN	Very Narrow Flood	4.0	4.3	20W	3900K	10	300	4590	83	74
MR16LED20CNF	Narrow Flood	4.0	4.3	20W	3900K	25	315	1980	84	79
MR16LED20CFL	Flood	4.0	4.3	20W	3900K	35	290	800	83	71
MR16LED20CVF	Wide Flood	4.0	4.3	20W	3900K	60	290	490	84	70
MR16LED35WVN	Very Narrow Flood	5.0	5.4	35W	2700K	10	365	3260	82	74
MR16LED35WNF	Narrow Flood	5.0	5.4	35W	2700K	25	370	1600	82	75
MR16LED35WFL	Flood	5.0	5.4	35W	2700K	35	335	840	82	65
MR16LED35WVF	Wide Flood	5.0	5.4	35W	2700K	60	340	450	82	71
MR16LED35CVN	Very Narrow Flood	5.0	5.4	35W	3900K	10	200	1920	83	39
MR16LED35CNF	Narrow Flood	5.0	5.4	35W	3900K	25	365	1700	84	72
MR16LED35CFL	Flood	5.0	5.4	35W	3900K	35	340	800	83	67
MR16LED35CVF	Wide Flood	5.0	5.4	35W	3900K	60	350	520	83	69



# PHOTOMETRICS: MR-16 LED 20W

MR16LED20WVN ILLUMINANCE AT A DISTANCE

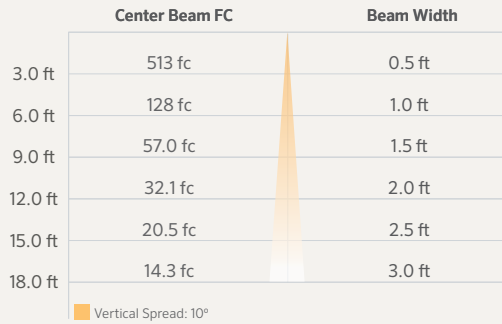

MR16LED20WNF ILLUMINANCE AT A DISTANCE

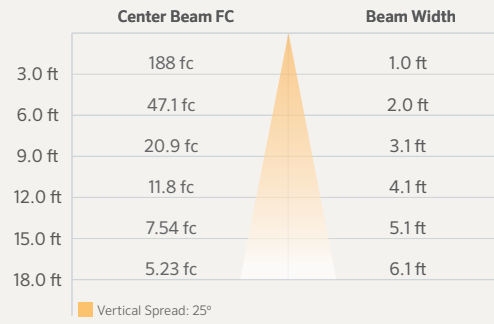

MR16LED20WFL ILLUMINANCE AT A DISTANCE

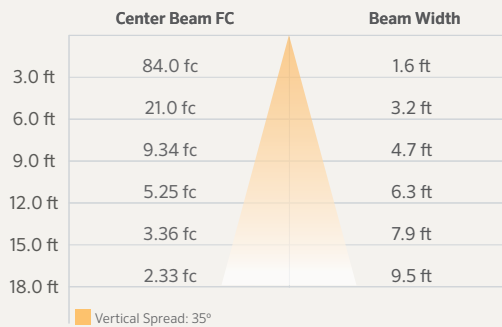

MR16LED20WWF ILLUMINANCE AT A DISTANCE

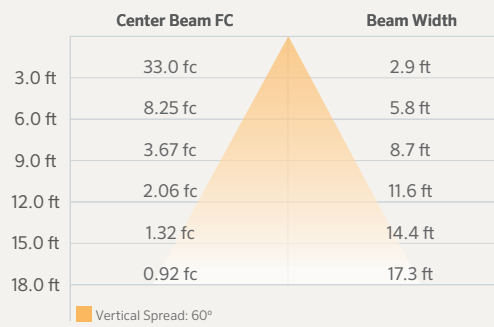

MR16LED20CVN ILLUMINANCE AT A DISTANCE

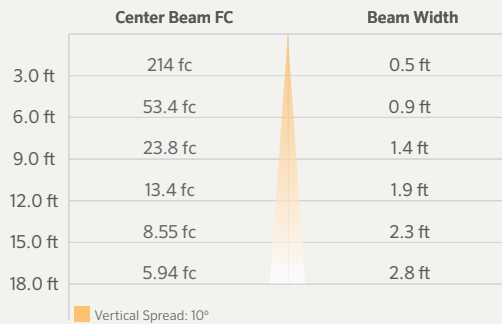

MR16LED20CNF ILLUMINANCE AT A DISTANCE

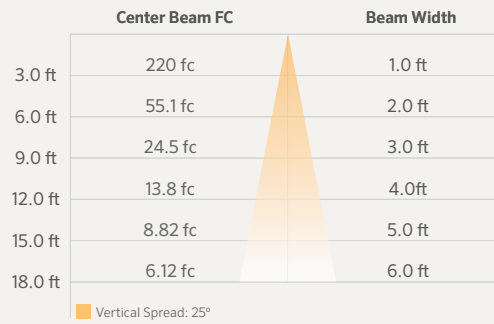

MR16LED20CFL ILLUMINANCE AT A DISTANCE

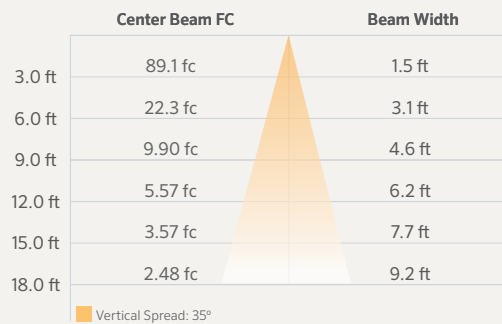

MR16LED20CWF ILLUMINANCE AT A DISTANCE

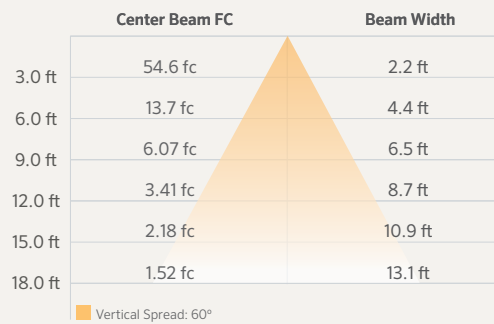

Beam angle is defined as two times the vertical angle at which the intensity is 50% of the maximum. It is calculated using LM-79 method for SSL Luminaires.

# PHOTOMETRICS: MR-16 LED 35W

MR16LED35WVN ILLUMINANCE AT A DISTANCE

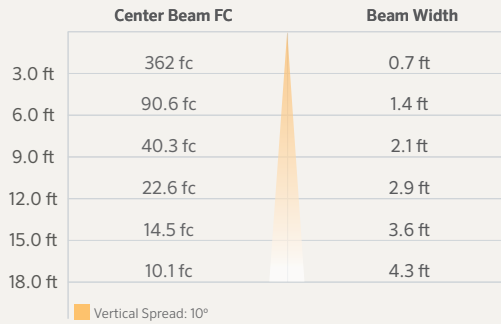

MR16LED35WNF ILLUMINANCE AT A DISTANCE

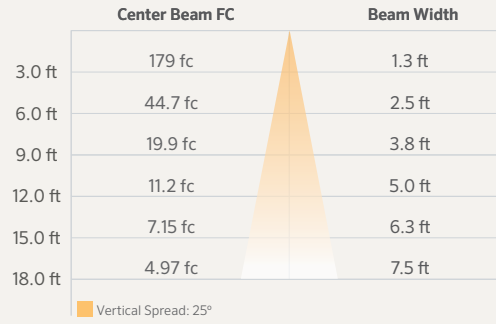

MR16LED35WFL ILLUMINANCE AT A DISTANCE

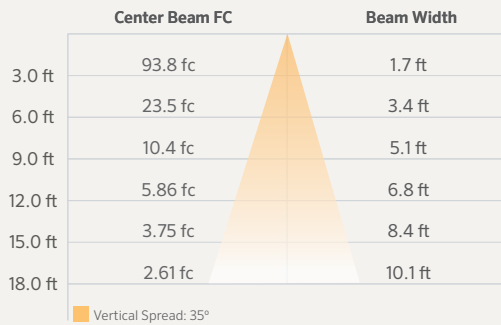

MR16LED35WWF ILLUMINANCE AT A DISTANCE

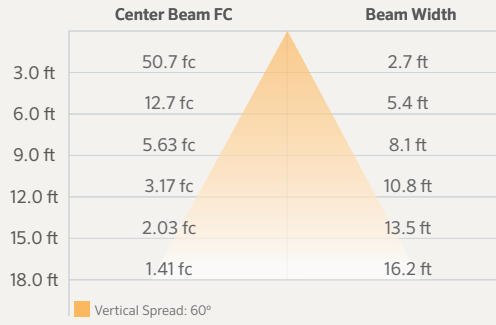

MR16LED35CVN ILLUMINANCE AT A DISTANCE

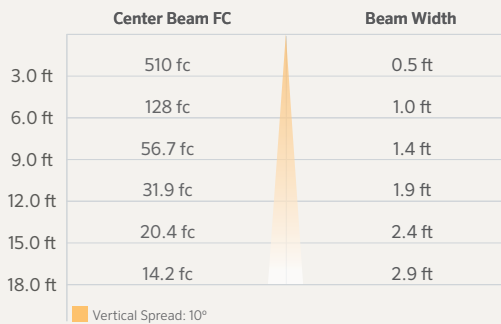

MR16LED35CNF ILLUMINANCE AT A DISTANCE

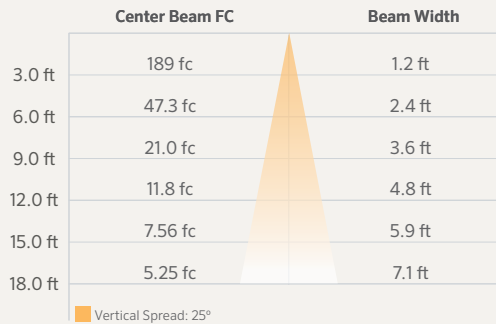

MR16LED35CFL ILLUMINANCE AT A DISTANCE

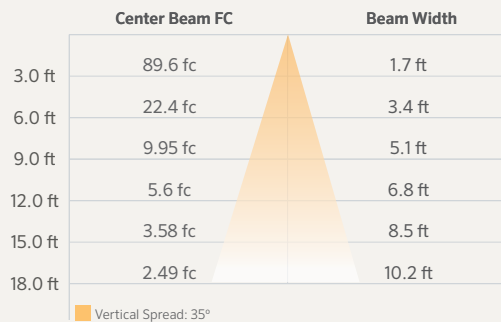

MR16LED35CWF ILLUMINANCE AT A DISTANCE

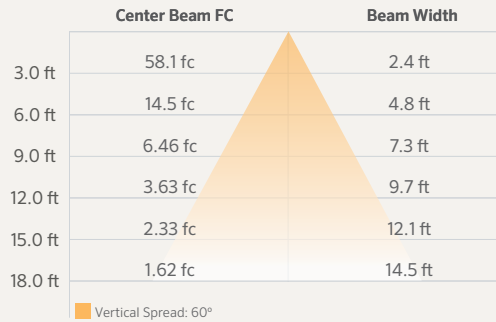

Beam angle is defined as two times the vertical angle at which the intensity is 50% of the maximum. It is calculated using LM-79 method for SSL Luminaires.